

YAMAHA T-300

*Natural Sound AM FM Stereo Tuner
Pilot Tone PLL Multiplex Demodulator
Signal Level Indicator
FM Muting*



OWNER'S MANUAL

Thank you for purchasing the YAMAHA T-300 AM/FM stereo tuner

CONTENTS	
CAUTION	1
CONNECTION DIAGRAM	3
CONNECTIONS	4
FRONT PANEL PARTS AND FUNCTIONS	5
LISTENING TO A BROADCAST	6
MULTIPATH INTERFERENCE	6
TROUBLESHOOTING/SPECIFICATIONS	7

IMPORTANT!

Please record the serial number of your unit in the space below:

Model : **T-300**

Serial No. :

The serial number is located on the rear of the chassis.

WARNING

To prevent fire or shock hazard, do not expose this appliance to rain or moisture.

CAUTION (PREPARED IN ACCORDANCE WITH UL STANDARD 1270)

1 Read Instructions — All the safety and operating instructions should be read before the appliance is operated.

2 Retain Instructions — The safety and operating instructions should be retained for future reference.

3 Heed Warnings — All warnings on the appliance and in the operating instructions should be adhered to.

4 Follow Instructions — All operating and other instructions should be followed.

5 Water and Moisture — The appliance should not be used near water — for example, near a bathtub, washbowl, kitchen sink, laundry tub, in a wet basement, or near swimming pool, etc.

6 Carts and Stands — The appliance should be used only with a cart or stand that is recommended by the manufacturer.

7 Wall or Ceiling Mounting — The appliance should be mounted to a wall or ceiling only as recommended by the manufacturer.

8 Ventilation — The appliance should be situated so that its location or position does not interfere with its proper ventilation. For example, the appliance should not be situated on a bed, sofa, rug, or similar surface that may block the ventilation openings; or placed in a built-in installation, such as a bookcase or cabinet that may impede the flow of air through the ventilation openings.

9 Heat — The appliance should be situated away from heat sources such as radiators, stoves, or other appliances that produce heat.

10 Power Sources — The appliance should be connected to a power supply only of the type described in the operating instructions or as marked on the appliance.

11 Power-Cord Protection — Power-supply cords should be routed so that they are not likely to be walked on or pinched by items placed upon or against them, paying particular attention to cords at plugs, convenience receptacles, and the point where they exit from the appliance.

12 Cleaning — The appliance should be cleaned only as recommended by the manufacturer.

13 Nonuse Periods — The power cord of the appliance should be unplugged from the outlet when left unused for a long period of time.

14 Object and Liquid Entry — Care should be taken so that objects do not fall into and liquids not spilled into the inside of the appliance.

15 Damage Requiring Service — The appliance should be serviced by qualified service personnel when:

- A. The power-supply cord or the plug has been damaged; or
- B. Objects have fallen, or liquid has been spilled into the appliance; or
- C. The appliance has been exposed to rain; or
- D. The appliance does not appear to operate normally or exhibits a marked change in performance; or
- E. The appliance has been dropped, or the cabinet damaged.

16 Servicing — The user should not attempt to service the appliance beyond those means described in the operating instructions. All other servicing should be referred to qualified service personnel.

17 Power Lines — An outdoor antenna should be located away from power lines.

18 Outdoor antenna grounding — If an outside antenna is connected to the tuner, be sure the antenna system is grounded so as to provide some protection against voltage surges and built up static charges. Section 810 of the National Electrical Code, ANSI/NFPA No. 70 — 1981, provides information with respect to proper grounding of the mast and supporting structure, grounding of the lead-in wire to an antenna discharge unit, size of grounding conductors, location of antenna-discharge unit, connection to grounding electrodes, and requirements for the grounding electrode.

EXAMPLE OF ANTENNA GROUNDING AS PER NATIONAL ELECTRICAL CODE INSTRUCTIONS

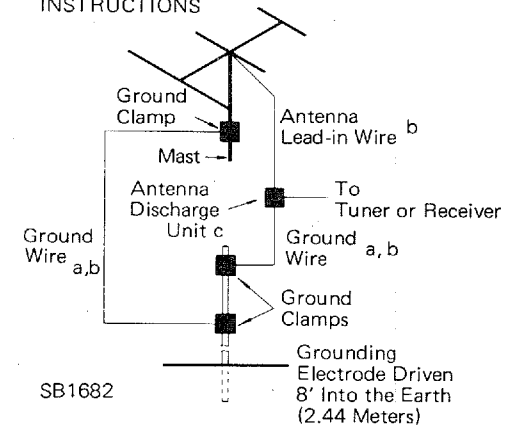

- a. Use No. 10 AWG (5.3 mm²) copper, No. 8 AWG (8.4 mm²) aluminium, No. 17 AWG (1.0 mm²) copper-clad steel or bronze wire, or larger, as ground wire.
- b. Secure antenna lead-in and ground wire to house with stand-off insulators spaced from 4 feet (1.22 meters) to 6 feet (1.83 meters) apart.
- c. Mount antenna discharge unit as closely as possible to where lead-in enters house.

T-300

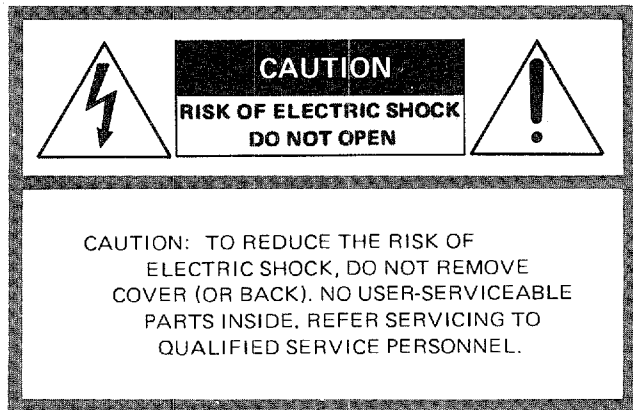

CAUTION: READ THIS BEFORE OPERATING YOUR T-300

• Explanation of Graphical Symbols



The lightning flash with arrowhead symbol, within an equilateral triangle, is intended to alert you to the presence of uninsulated "dangerous voltage" within the product's enclosure that may be of sufficient magnitude to constitute a risk of electric shock to persons.

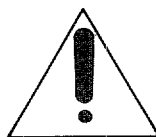

The exclamation point within an equilateral triangle is intended to alert you to the presence of important operating and maintenance (servicing) instructions in the literature accompanying the appliance.

1

The T-300 is a sophisticated AM/FM stereo tuner. To ensure proper operation for the best possible sound reproduction, please read this manual carefully.

2

Choose the installation location of your T-300 carefully. Avoid placing it in direct sunlight or close to a source of heat. Also avoid locations subject to vibration and excessive dust, heat, cold or moisture.

3

Do not open the cabinet as this might result in damage to the set, or electrical shock. If a foreign object should get into the set, contact your dealer.

4

To prevent lightning damage, pull out the power cord and remove the antenna cable during an electrical storm.

5

When removing the power plug from the wall outlet, always pull directly on the plug; never yank the cord.

6

Do not use force when using the switches or knobs.

7

When moving the set be sure to first pull out the power plug and remove cords connecting to other equipment.

8

Do not attempt to clean the T-300 with chemical solvents as this might damage the finish. Use a clean, dry cloth.

9

Be sure to read the "troubleshooting" section for advice on common operating errors before concluding that your T-300 is faulty.

10

Keep this manual in a safe place for future reference.

T-300

CONNECTION DIAGRAM

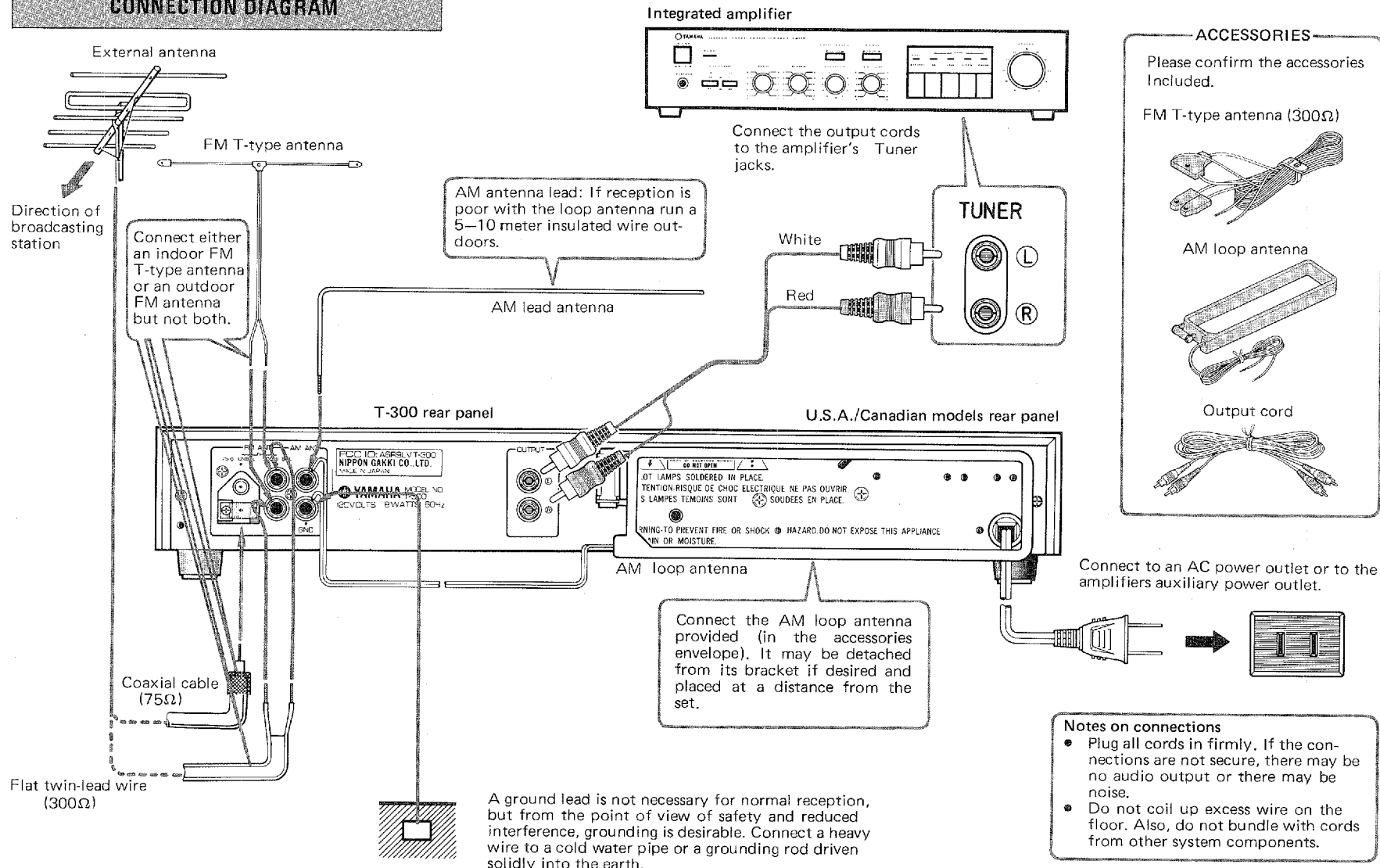

CONNECTIONS

● CONNECTING THE FM ANTENNA

Choose an FM antenna that is appropriate to the local reception conditions. Consider the distance from the broadcast station and possible interfering objects such as surrounding tall buildings. In cases where there is a strong signal from a local station, a portable T-type antenna is usually adequate. Connect the feeder wire to the 300 ohms terminal, stretch the wire out tight, and turn to obtain optimum reception. Attach to a suitable support such as a wall.

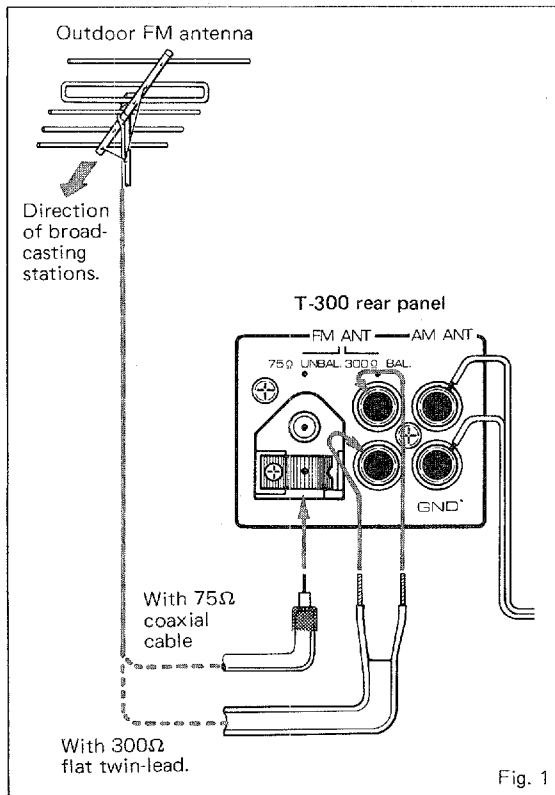

Find the optimum reception

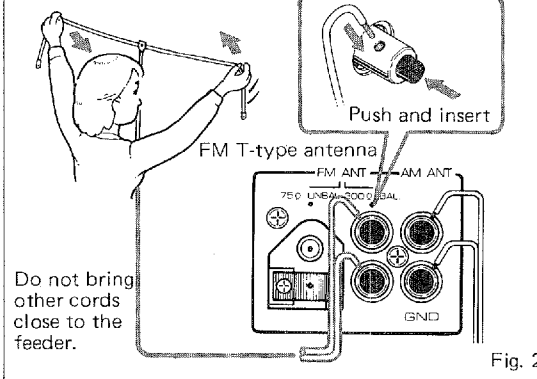

In all but the best reception conditions, an outdoor FM antenna is necessary for best results. Either 300Ω flat twin-lead wire or 75Ω coaxial cable may be used. In locations where electrical interference is a problem, coaxial cable is preferable. Refer to the Fig. 3 for instructions on connecting the coaxial cable.

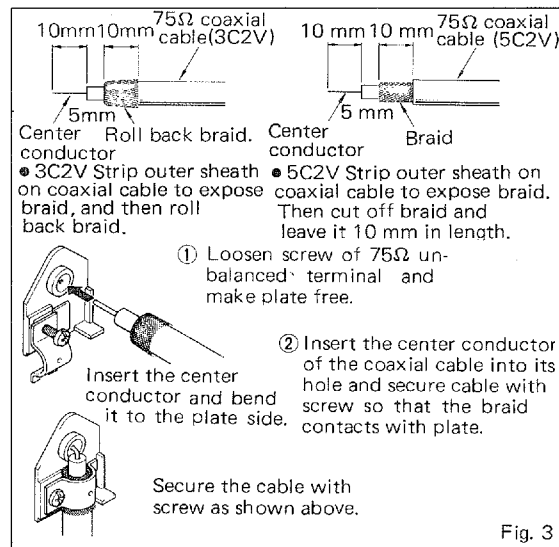

● CONNECTING THE AM ANTENNA

In many cases it will be possible to get excellent AM reception with the provided AM loop antenna. Attach the antenna leads to the Gnd and AM ANT terminals and rotate the antenna in its bracket for best reception. The loop antenna may also be removed and hung on the wall.

If necessary, an outdoor antenna may be used for improved AM reception. Connect a 5 – 10 meter length of insulated wire to the AM ANT terminal and run it outdoors.

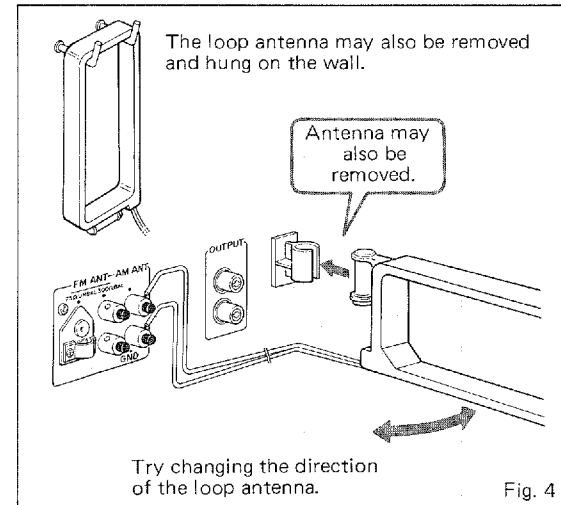

● CONNECTING THE AMPLIFIER

Use the cable supplied to connect from the output cords to the tuner input jacks of your amplifier, being sure to observe the left and right channel markings. Also make sure that the connections are secure and that the connecting cable is not bundled with the speaker leads or power cord from the amplifier.

T-300

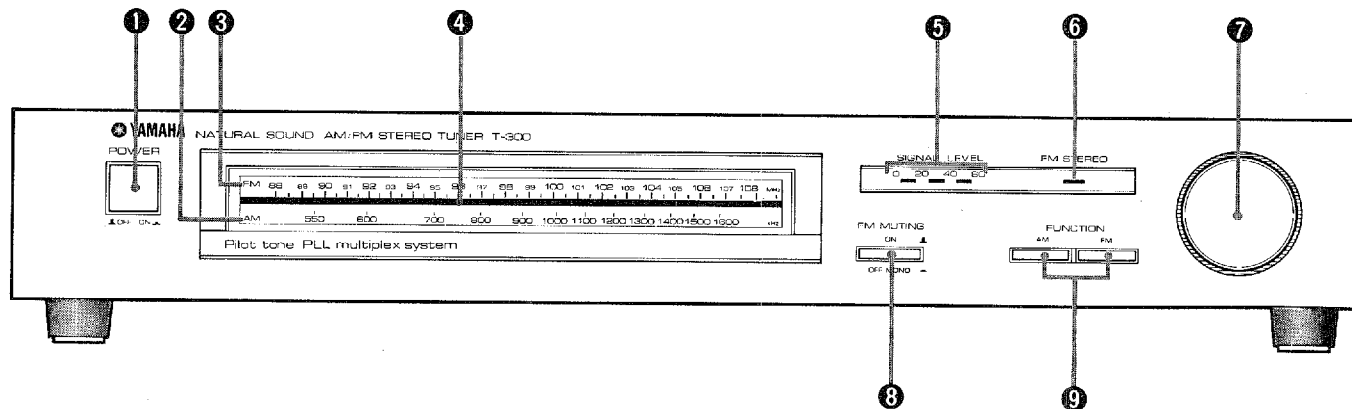

FRONT PANEL PARTS AND FUNCTIONS

1 POWER SWITCH

This is a "push-on, push-off" type power switch. When power is turned on the red dial pointer and the dial illumination lamps will light.

2 AM DIAL SCALE

This is used for AM tuning and displays the frequency of the received AM station in kHz.

3 FM DIAL SCALE

This is used for FM tuning and displays the frequency of the received FM station in MHz.

4 DIAL POINTER

Rotate the tuning knob until this pointer is lined up with the frequency of the station to be tuned in.

5 SIGNAL LEVEL INDICATOR

When tuning in a station, rotate the tuning knob so that this indicator shows maximum signal strength.

* In the case of FM reception, a slight flickering indicates the presence of multipath interference. This can be eliminated by using a directional FM antenna and adjusting its height and direction until the display is stable.

6 FM STEREO INDICATOR

When a received FM station is in stereo this indicator automatically lights, while on mono broadcasts it is unlit.

* When the FM Muting switch is in the Off/Mono (—) position the indicator will not light.

7 TUNING KNOB

This knob is used to tune in stations. Rotate the knob while observing the tuning indicator adjusting for best reception.

8 FM MUTING SWITCH

Turning this switch on (■) activates the muting circuit and silences the noise that would otherwise be heard between FM stations.

When the received station is very weak, however, it too will be silenced. Therefore, when you want to listen to a very weak station, the switch should be set to the Off/Mono (—) position.



* In the Off/Mono position, even FM stereo broadcasts will be heard in mono.

9 FUNCTION SWITCH

Select either FM or AM broadcasts.



LISTENING TO A BROADCAST

● LISTENING TO FM BROADCASTS

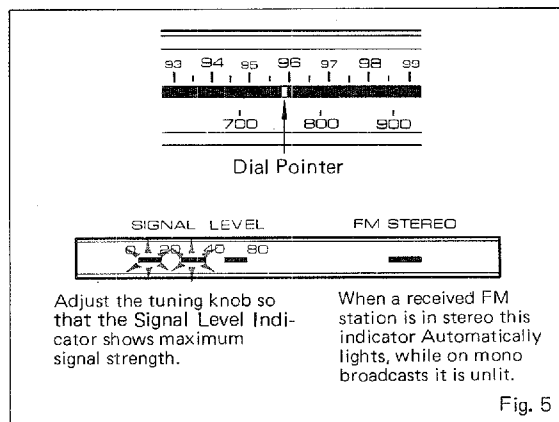
1. Set the Power switch to On ().
 2. Set the Function switch to FM.
 3. Next, set the FM MUTING switch to On ().
 4. Rotate the tuning knob so that the dial pointer lines up with the frequency of the desired station. Adjust the tuning knob so that the Signal Level Indicator shows maximum signal strength.
- * When listening to a weak, distant station or when there is interference from another station, setting the FM MUTING switch to the Off/Mono () position will cause the station to be received in mono and considerably reduce noise.



● LISTENING TO AM BROADCASTS

1. Set the Power Switch to On ().
2. Set the Function Switch to AM ().
3. Rotate the tuning knob so that the dial pointer lines up with the frequency of the desired station. Adjust the tuning knob so that the Signal Level Indicator shows maximum signal strength.

MULTIPATH INTERFERENCE

Multipath is an effect similar to television ghosting; it distorts the received signal and also causes poor stereo separation and noise. As shown in fig. radio waves which travel directly from the transmitter to the receiving antenna are mixed with waves which reflect off nearby objects such as buildings. Because the path taken by the reflected waves is longer than the direct path, the time required for the waves to arrive at the antenna is also longer. The mixing of the directly received signal and the delayed signal noticeably degrades reception quality. Multipath interference can be greatly reduced by the use of a high-quality directional antenna oriented in the proper direction.

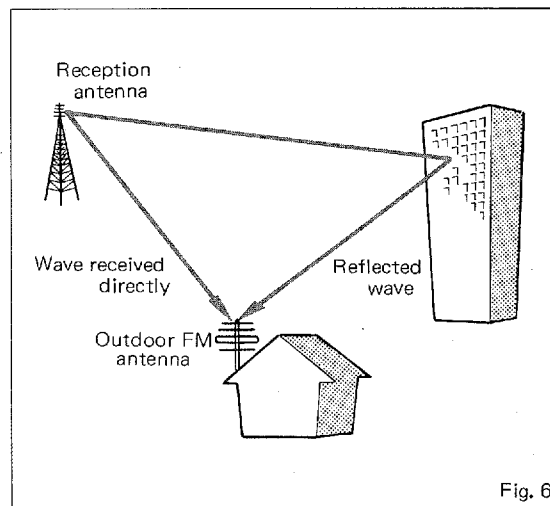

T-300

TROUBLESHOOTING

Before assuming that your tuner is faulty, check the following troubleshooting list which details the corrective action you can take yourself without having to call a service engineer. If you have any doubts or questions, get in touch with your nearest Yamaha dealer.

	Fault	Cause	Cure
FM	Crackling sounds from time to time (especially in weak signal areas).	Ignition noise from vehicles.	The FM antenna should be put up as high as possible, away from the road and a coaxial cable used.
		Noise from thermostats and other electrical equipment.	Attach a noise suppressor to the equipment causing the noise.
	The FM stereo reception is noisy.	Because of the characteristics of FM stereo broadcasts, this is limited to cases where the transmitter is far away or the antenna input is poor.	Check the antenna connections.
			Try using a multiple element FM antenna.
	The FM Stereo indicator flickers on and off and reception is noisy.	Insufficient antenna input.	Use an antenna appropriate for the reception conditions in your area.
			Not tuned correctly.
	There is distortion and clear reception cannot be obtained even with a good FM antenna.	There is multipath interference.	Adjust antenna placement to eliminate multipath interference.
No stereo effect even with a stereo broadcast.	MUTING switch is set to Off/Mono.	Set the FM MUTING switch properly.	
AM	Insufficient sensitivity.	Weak signal or loose antenna connections.	Tighten the AM loop antenna connections and rotate it for best reception.
			Use an outdoor antenna.
	There are continuous crackling and hissing noises.	These noises result from lightning, fluorescent lamps, motors, thermostats and other electrical equipment.	Use an outdoor antenna and a ground wire. This will help somewhat but it is difficult to eliminate all noise.
There are buzzing and whining noises.	Another station is interfering with the received station.	This is impossible to remedy.	
	A television set is being used nearby.	Move the television a distance away.	

SPECIFICATIONS

FM SECTION

Tuning Range	87.6 ~ 108MHz
50dB Quieting Sensitivity Mono	3.1 μ V (15.1dBf)
Stereo	42 μ V (37.7dBf)
Usable Sensitivity (IHF mono)	
75 Ω	0.8 μ V (9.3dBf)
300 Ω	1.6 μ V (9.3dBf)
Image Response Ratio	40dB
IF Response Ratio	100dB
Spurious Response Ratio	80dB
AM Suppression Ratio (IHF)	55dB
Capture Ratio	1.5dB
Alternate Channel Selectivity	85dB
Signal-to-Noise Ratio (IHF) Mono	81dB
Stereo	76dB
Harmonic Distortion	
Mono 1kHz	0.15%
Stereo 1kHz	0.3%
Stereo Separation 1kHz	40dB
Frequency Response	
50Hz ~ 10kHz	\pm 0.5dB
Sub-carrier Product Ratio	35dB
Muting Threshold	10 μ V (25.2dBf)

AM SECTION

Tuning Range	525 ~ 1605kHz
Usable Sensitivity (IHF, Loop Ant.)	10 μ V
Selectivity (\pm 10kHz)	24dB
Signal-to-Noise Ratio	50dB
Image Response Ratio	40dB
Spurious Response Ratio	50dB
Harmonic Distortion	0.5%

AUDIO SECTION

Output Level/Impedance	
FM (100% mod. 1kHz)	500mV/2k Ω
AM (30% mod. 400Hz)	150mV/2k Ω

GENERAL

Power Supply	AC 120V, 60Hz
Power Consumption	8W
Dimensions (W x H x D)	435x72x299mm (17-1/8x2-7/8x 11-3/4)"
Weight	3.2 kg (7.1 lbs)

Specifications subject to change without notice.

SINCE 1887



YAMAHA

NIPPON GAKKI CO., LTD. HAMAMATSU, JAPAN
8210 Printed in Japan ©